



GREJANJE I HLAĐENJE

FX Fan-coil





FX Fan Coil sa AC električnim motorom i autotransformatorom

Unapredite svoj sistem grejanja i hlađenja - izaberite fleksibilnost i efikasnost!



Ključne Karakteristike:



- Dostupne su 3 različite motorizacije: AC~230V(FX tradicionalni, FX-P pojačani, FX-S super-tihi)
- Tihi ventilator: Nisko obrtni, izbalansirani ventilator za superiornu tišinu.
- Prilagodljive rešetke: Rešetke sa podesivim lamelama za kontrolu smera protoka vazduha, uključujući opcije za povećanje efekata indukcije i efekta.
- Efikasni vazdušni filter: Lako se skida i čisti za održavanje kvaliteta vazduha.
- Elegantan dizajn: Čvrste, kompaktne jedinice s modernim izgledom.
- Fleksibilne hidraulične konekcije: Mogućnost izbora strane konekcija plus jednostavno održavanje.

Seriya proizvoda	Motor ventilatora	[kW]	[kW]	[m/h]	ESP [Pa]
FX	AC~230V-Standard 3Brz./Brzina	1,5+10,0	3,7+21,7	370+1.750	Max 75
FX-P	AC~230V-Pojačan 3Brz./Brzina	1,6+10,7	4,0+23,2	410+1.940	Max 90
FX-S	AC~230V-Supertihio 3Brz./Brzina	1,0+6,8	2,5+14,3	200+930	Max 45

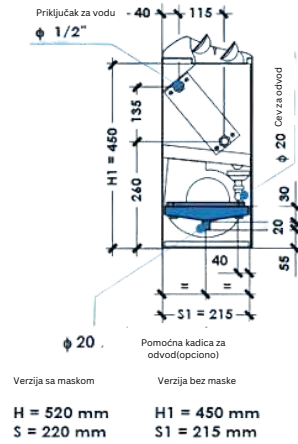
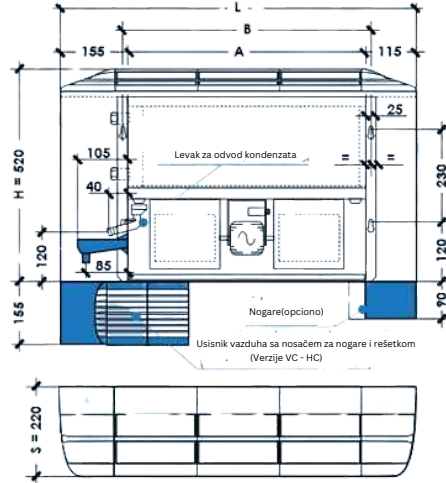

FX(VA)



Nominalni tehnički podaci (jedinice dvocevnog sistema sa standardnim AC motorom)

Veličina		FX	130	230	330	430	530	630	730	830	930	1030	1130	1230	
Kapacitet hlađenja	Total	W	1.500	2.000	2.530	3.020	3.750	4.250	5.520	6.420	7.530	9.020	8.990	10.040	
	Senzibilni	W	1.290	1.620	2.070	2.310	2.870	3.230	4.330	4.800	5.670	6.620	7.080	7.760	
Kapacitet grejanja		W	3.740	4.910	5.980	6.710	8.160	9.440	12.000	13.300	15.500	18.100	19.690	21.670	
Nominalni protok vazduha		m ³ /h	370	400	500	550	670	720	1.000	1.050	1.280	1.310	1.720	1.750	
Protok vode	Hlađenje	l/h	258	344	436	520	645	731	950	1.105	1.296	1.552	1.546	1.727	
	Grejanje	l/h	322	423	515	578	702	812	1.032	1.144	1.333	1.557	1.693	1.864	
Padovi pritiska vode	Hlađenje	kPa	13,1	16,3	18,5	20,8	22,6	24,1	24,5	27,1	28,8	29,2	27,2	29,4	
	Grejanje	kPa	15,9	19,2	20,1	20,0	20,9	23,2	22,6	22,7	23,8	22,9	25,4	26,7	
Nivoi buke		Min-Med-Max dB(A)	24-31-38	25-31-38	30-38-44	31-38-45	26-33-37	27-34-37	34-41-43	35-41-45	39-46-48	40-46-49	42-44-49	42-45-49	
Ref. FAN-DECK			C2, A40.6V, [P2-3-5], [NI-2-4]		C3.15, A40.6V, [P2-3-5], [NI-2-4]		C3.15, A80.6V, [P2-3-5], [NI-2-4]		C5, A80.6V, [P2-3-5], [NI-2-4]		C3.15, A80.6V, [P2-3-5], [NI-2-4]		C3.15, 5V, [P2-3-4], [ND1-3-4]		
Motori/Ventilatori		No.	1/1		1/1		1/2		1/2		1/2		1/3		
Nominalna ulazna struja		MAX W	55 W		80 W		80 W		145 W		180 W		290 W		
		MAX. A	0,25 A		0,35 A		0,35 A		0,65 A		0,80 A		1,30 A		
Napajanje			230Vac-1Ph-50/60Hz												
Grejno/hladni blok		Zapremina vode (l)	0,69	0,70	0,99	1,01	1,30	1,31	1,60	1,62	1,91	1,92	2,21	2,23	
		[Ranghi], DN(°) - [Rows], DN(°)	[3R], 1/2" F		[3R], 1/2" F		[3R], 1/2" F		[3R], 1/2" F		[3R], 1/2" F		[3R], 1/2" F		
Odvodna cev		(mm)	20												
Osnovne dimenzije		L mm	670		870		1.070		1.270		1.470		1.670		
		H mm	470		470		470		470		470		470		
		S mm	220		220		220		220		220		220		
		A mm	400		600		800		1.000		1.200		1.400		
B mm			425		625		825		1.025		1.025		1.425		
Donja radna granica		LFI ESP = 0 Pa	Max	1,00	1,00	1,00	1,00	1,00	1,00	1,00	1,00	1,00	1,00	1,00	
			Med	0,77	0,77	0,80	0,80	0,88	0,88	0,89	0,89	0,89	0,89	0,86	0,86
			Min	0,61	0,61	0,61	0,61	0,69	0,69	0,65	0,65	0,68	0,68	0,78	0,78
		15 Pa	Max	0,94	0,94	0,92	0,92	0,92	0,92	0,91	0,91	0,94	0,94	0,95	0,95
			Med	0,69	0,69	0,71	0,71	0,77	0,77	0,79	0,79	0,84	0,84	0,82	0,82
SMANJENJE PROTOKA VAZDUHA Koefficienti koji definišu dijagrame "Protok vazduha / Statički pritisak" (na 3 brzine Maks-Sred- Min)		30 Pa	Max	0,85	0,85	0,83	0,83	0,81	0,81	0,83	0,83	0,87	0,87	0,90	0,90
			Med	0,59	0,59	0,61	0,61	0,66	0,66	0,70	0,70	0,79	0,79	0,78	0,78
			Min	0,37	0,37	0,41	0,41	0,45	0,45	0,50	0,50	0,59	0,59	0,70	0,70
		45 Pa	Max	0,75	0,75	0,71	0,71	0,70	0,70	0,73	0,73	0,79	0,79	0,83	0,83
			Med	0,48	0,48	0,50	0,50	0,55	0,55	0,61	0,61	0,72	0,72	0,72	0,72
Gornja radna granica		LFS	Max	86 Pa	86 Pa	86 Pa	86 Pa	98 Pa	98 Pa	103 Pa	103 Pa	113 Pa	113 Pa	119 Pa	119 Pa
			Med	75 Pa	75 Pa	76 Pa	76 Pa	90 Pa	90 Pa	97 Pa	97 Pa	109 Pa	109 Pa	113 Pa	113 Pa
			Min	56 Pa	56 Pa	57 Pa	57 Pa	68 Pa	68 Pa	80 Pa	80 Pa	99 Pa	99 Pa	111 Pa	111 Pa
		ESP (Pa) Qa (x m ³ /h)	Max	86 Pa x 0,20	86 Pa x 0,20	86 Pa x 0,20	86 Pa x 0,20	98 Pa x 0,20	98 Pa x 0,20	103 Pa x 0,20	103 Pa x 0,20	113 Pa x 0,20	113 Pa x 0,20	119 Pa x 0,20	119 Pa x 0,20
			Med	75 Pa x 0,19	75 Pa x 0,19	76 Pa x 0,19	76 Pa x 0,19	90 Pa x 0,19	90 Pa x 0,19	97 Pa x 0,19	97 Pa x 0,19	109 Pa x 0,20	109 Pa x 0,20	113 Pa x 0,19	113 Pa x 0,19
ESP (Pa) Qa (x m ³ /h)		Min	Max	56 Pa x 0,16	56 Pa x 0,16	57 Pa x 0,16	57 Pa x 0,16	68 Pa x 0,17	68 Pa x 0,17	80 Pa x 0,18	80 Pa x 0,18	99 Pa x 0,19	99 Pa x 0,19	111 Pa x 0,19	
			Med	75 Pa x 0,19	75 Pa x 0,19	76 Pa x 0,19	76 Pa x 0,19	90 Pa x 0,19	90 Pa x 0,19	97 Pa x 0,19	97 Pa x 0,19	109 Pa x 0,20	109 Pa x 0,20	113 Pa x 0,19	113 Pa x 0,19

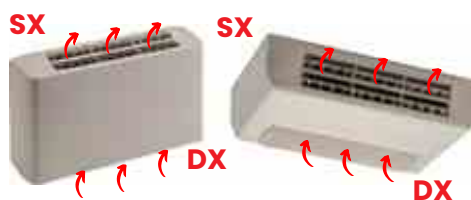

Navedite stranu priključaka za vodu

- SX = Levo (STANDARD)
- DX = Desno

Veličina	FX	130	230	330	430	530	630	730	830	930	1030	1130	1230
Ukupni kapacitet hlađenja	W	1.500	2.000	2.530	3.020	3.750	4.250	5.520	6.420	7.530	9.020	8.990	10.040
Ukupni kapacitet grejanja	W	3.740	4.910	5.980	6.710	8.160	9.440	12.000	13.300	15.500	18.100	19.690	21.670
Protok vazduha	m ³ /h	370	400	500	550	670	720	1.000	1.050	1.280	1.310	1.720	1.750
Nivo buke	Min-Med-Max dB(A)	24-31-38	25-31-38	25-31-38	30-38-44	26-33-37	27-34-37	34-41-43	35-41-45	39-46-48	40-46-49	42-44-49	42-45-49
VA Vertikalna zidna verzija (osnovna maska)													
	Mod.	FX-VA 130	FX-VA 230	FX-VA 330	FX-VA 430	FX-VA 530	FX-VA 630	FX-VA 730	FX-VA 830	FX-VA 930	FX-VA 1030	FX-VA 1130	FX-VA 1230
	(*) kg	13,5	14,0	16,4	17,2	22,5	23,5	26,0	27,5	30,0	31,5	32,9	36,4
	L x H x S	670 x 520 x 220		870 x 520 x 220		1.070 x 520 x 220		1.270 x 520 x 220		1.470 x 520 x 220		1.670 x 520 x 220	
VB Vertikalna podna verzija (maska s rešetkom za prednje usisavanje vazduha)													
	Mod.	FX-VB 130	FX-VB 230	FX-VB 330	FX-VB 430	FX-VB 530	FX-VB 630	FX-VB 730	FX-VB 830	FX-VB 930	FX-VB 1030	FX-VB 1130	FX-VB 1230
	(*) kg	13,8	14,3	16,9	17,7	23,2	24,2	26,9	28,4	31,1	32,6	34,2	37,7
	L x H x S	670 x 520 x 220		870 x 520 x 220		1.070 x 520 x 220		1.270 x 520 x 220		1.470 x 520 x 220		1.670 x 520 x 220	
VC Vertikalna podna verzija (maska s potporom za usis vazduha na podu + rešetkom)													
	Mod.	FX-VC 130	FX-VC 230	FX-VC 330	FX-VC 430	FX-VC 530	FX-VC 630	FX-VC 730	FX-VC 830	FX-VC 930	FX-VC 1030	FX-VC 1130	FX-VC 1230
	(*) kg	15,0	15,5	18,2	19,0	24,6	25,6	28,4	29,9	32,7	34,2	35,9	39,4
	L x H x S	670 x 675 x 220		870 x 675 x 220		1.070 x 675 x 220		1.270 x 675 x 220		1.470 x 675 x 220		1.670 x 675 x 220	
HA Horizontalna verzija na plafonu (osnovna maska)													
	Mod.	FX-HA 130	FX-HA 230	FX-HA 330	FX-HA 430	FX-HA 530	FX-HA 630	FX-HA 730	FX-HA 830	FX-HA 930	FX-HA 1030	FX-HA 1130	FX-HA 1230
	(*) kg	14,7	15,2	18,0	18,8	24,5	25,5	28,4	29,9	32,8	34,3	36,1	39,6
	L x H x S	670 x 520 x 220		870 x 520 x 220		1.070 x 520 x 220		1.270 x 520 x 220		1.470 x 520 x 220		1.670 x 520 x 220	
HB Horizontalna verzija na plafonu (maska s rešetkom za prednje usisavanje vazduha)													
	Mod.	FX-HB 130	FX-HB 230	FX-HB 330	FX-HB 430	FX-HB 530	FX-HB 630	FX-HB 730	FX-HB 830	FX-HB 930	FX-HB 1030	FX-HB 1130	FX-HB 1230
	(*) kg	15,0	15,5	18,5	19,3	25,2	26,2	29,3	30,8	33,9	35,4	37,4	40,9
	L x H x S	670 x 520 x 220		870 x 520 x 220		1.070 x 520 x 220		1.270 x 520 x 220		1.470 x 520 x 220		1.670 x 520 x 220	
HC Horizontalna verzija na plafonu (maska s potporom za usis zraka na nogama + rešetkom)													
	Mod.	FX-HC 130	FX-HC 230	FX-HC 330	FX-HC 430	FX-HC 530	FX-HC 630	FX-HC 730	FX-HC 830	FX-HC 930	FX-HC 1030	FX-HC 1130	FX-HC 1230
	(*) kg	16,2	16,7	19,8	20,6	26,6	27,6	30,8	32,3	35,5	37,0	39,1	42,6
	L x H x S	670 x 675 x 220		870 x 675 x 220		1.070 x 675 x 220		1.270 x 675 x 220		1.470 x 675 x 220		1.670 x 675 x 220	

- (*) kg = Neto težina (samo jedinica, bez pakovanja)
- L x H x S = Dužina x Visina x Dubina (dimenzije u mm)

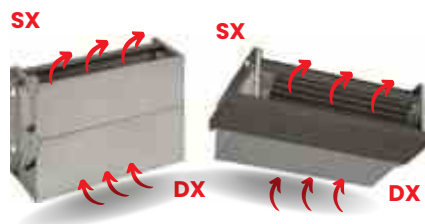

Navedite stranu priključaka za vodu

- SX = Levo (STANDARD)
- DX = Desno

Veličina	FX	130	230	330	430	530	630	730	830	930	1030	1130	1230
Ukupni kapacitet hlađenja	W	1.500	2.000	2.530	3.020	3.750	4.250	5.520	6.420	7.530	9.020	8.990	10.040
Ukupni kapacitet grejanja	W	3.740	4.910	5.980	6.710	8.160	9.440	12.000	13.300	15.500	18.100	19.690	21.670
Protok vazduha	m ³ / h	370	400	500	550	670	720	1.000	1.050	1.280	1.310	1.720	1.750
Nivo buke	Min-Med-Max dB(A)	24-31-38	25-31-38	25-31-38	30-38-44	26-33-37	27-34-37	34-41-43	35-41-45	39-46-48	40-46-49	42-44-49	42-45-49
CA Vertikalna skrivena verzija (osnovna; bez maske)													
	Mod.	FX-CA 130	FX-CA 230	FX-CA 330	FX-CA 430	FX-CA 530	FX-CA 630	FX-CA 730	FX-CA 830	FX-CA 930	FX-CA 1030	FX-CA 1130	FX-CA 1230
	(*) kg	10,7	11,2	13,5	14,3	19,5	20,5	22,9	24,4	26,8	28,3	29,6	33,1
	L x H x S	450 x 450 x 215		650 x 450 x 215		850 x 450 x 215		1.050 x 450 x 215		1.250 x 450 x 215		1.450 x 450 x 215	
CB Vertikalna skrivena verzija (prednje usisavanje vazduha; bez maske)													
	Mod.	FX-CB 130	FX-CB 230	FX-CB 330	FX-CB 430	FX-CB 530	FX-CB 630	FX-CB 730	FX-CB 830	FX-CB 930	FX-CB 1030	FX-CB 1130	FX-CB 1230
	(*) kg	10,6	11,1	13,4	14,2	19,4	20,4	22,7	24,2	26,6	28,1	29,4	32,9
	L x H x S	450 x 450 x 215		650 x 450 x 215		850 x 450 x 215		1.050 x 450 x 215		1.250 x 450 x 215		1.450 x 450 x 215	
CC Vertikalna skrivena verzija (prednji dovod vazduha; bez maske)													
	Mod.	FX-CC 130	FX-CC 230	FX-CC 330	FX-CC 430	FX-CC 530	FX-CC 630	FX-CC 730	FX-CC 830	FX-CC 930	FX-CC 1030	FX-CC 1130	FX-CC 1230
	(*) kg	11,1	11,6	14,1	14,9	20,3	21,3	23,9	25,4	28,0	29,5	31,0	34,5
	L x H x S	450 x 450 x 215		650 x 450 x 215		850 x 450 x 215		1.050 x 450 x 215		1.250 x 450 x 215		1.450 x 450 x 215	
CD Vertikalna skrivena verzija (prednje usisavanje i dovod vazduha; bez maske)													
	Mod.	FX-CD 130	FX-CD 230	FX-CD 330	FX-CD 430	FX-CD 530	FX-CD 630	FX-CD 730	FX-CD 830	FX-CD 930	FX-CD 1030	FX-CD 1130	FX-CD 1230
	(*) kg	11,0	11,5	14,0	14,8	20,2	21,2	23,7	25,2	27,8	29,3	30,8	34,3
	L x H x S	450 x 450 x 215		650 x 450 x 215		850 x 450 x 215		1.050 x 450 x 215		1.250 x 450 x 215		1.450 x 450 x 215	
CH Horizontalna skrivena verzija (osnovna; bez maske) - Ugaono nagnuto filtriranje prema dole, usis vazduha NIJE kanaliziran													
	Mod.	FX-CH 130	FX-CH 230	FX-CH 330	FX-CH 430	FX-CH 530	FX-CH 630	FX-CH 730	FX-CH 830	FX-CH 930	FX-CH 1030	FX-CH 1130	FX-CH 1230
	(*) kg	11,1	11,6	13,9	14,7	19,9	20,9	23,3	24,8	27,2	28,7	30,0	33,5
	L x H x S	545 x 450 x 215		745 x 450 x 215		945 x 450 x 215		1.145 x 450 x 215		1.345 x 450 x 215		1.545 x 450 x 215	
CK Horizontalna skrivena verzija (prednje usisavanje vazduha; bez maske)													
	Mod.	FX-CK 130	FX-CK 230	FX-CK 330	FX-CK 430	FX-CK 530	FX-CK 630	FX-CK 730	FX-CK 830	FX-CK 930	FX-CK 1030	FX-CK 1130	FX-CK 1230
	(*) kg	11,0	11,5	13,8	14,6	19,8	20,8	23,1	24,6	27,0	28,5	29,8	33,3
	L x H x S	545 x 450 x 215		745 x 450 x 215		945 x 450 x 215		1.145 x 450 x 215		1.345 x 450 x 215		1.545 x 450 x 215	
CS Horizontalna skrivena verzija (osnovna; bez maske) - Vertikalno filtriranje dole, usis vazduha kanaliziran													
	Mod.	FX-CS 130	FX-CS 230	FX-CS 330	FX-CS 430	FX-CS 530	FX-CS 630	FX-CS 730	FX-CS 830	FX-CS 930	FX-CS 1030	FX-CS 1130	FX-CS 1230
	(*) kg	11,2	11,7	14,0	14,8	20,0	21,0	23,4	24,9	27,3	28,8	30,1	33,6
	L x H x S	545 x 450 x 215		745 x 450 x 215		945 x 450 x 215		1.145 x 450 x 215		1.345 x 450 x 215		1.545 x 450 x 215	
CT Horizontalna skrivena verzija (osnovna; bez maske) - Vertikalno filtriranje prema gore, usis vazduha kanaliziran													
	Mod.	FX-CT 130	FX-CT 230	FX-CT 330	FX-CT 430	FX-CT 530	FX-CT 630	FX-CT 730	FX-CT 830	FX-CT 930	FX-CT 1030	FX-CT 1130	FX-CT 1230
	(*) kg	11,2	11,7	14,0	14,8	20,0	21,0	23,4	24,9	27,3	28,8	30,1	33,6
	L x H x S	545 x 450 x 215		745 x 450 x 215		945 x 450 x 215		1.145 x 450 x 215		1.345 x 450 x 215		1.545 x 450 x 215	

- (*) kg = Neto težina (samo jedinica, bez pakovanja)
- L x H x S = Dužina x Visina x Dubina (dimenzije u mm)

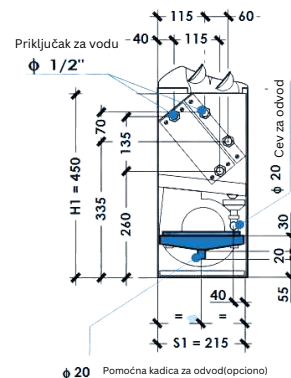
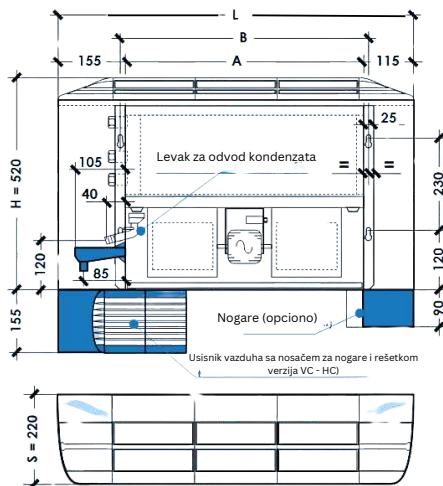

Verzija sa maskom
H = 520 mm
S = 220 mm

FX(VA)



Nominalni tehnički podaci (jedinice za četvorocjevni sistem sa standardnim AC motorom)

Veličina		FX	131	231	331	431	531	631	731	831	931	1031	1131	1231
Kapacitet hlađenja	Total	W	1.450	1.940	2.470	2.920	3.650	4.110	5.390	6.230	7.350	8.810	8.840	9.870
	Senzibilni	W	1.240	1.570	2.020	2.220	2.780	3.110	4.210	4.640	5.520	6.440	6.940	7.610
Kapacitet grejanja		W	1.880	1.980	3.180	3.350	4.380	4.550	6.290	6.460	7.990	8.110	10.360	10.480
Nominalni protok vazduha		m ³ /h	350	380	480	520	640	680	960	1.000	1.230	1.260	1.670	1.700
Protok vode	Hlađenje	l/h	250	334	425	503	628	707	928	1.072	1.265	1.516	1.520	1.698
	Grejanje	l/h	162	171	274	289	377	392	541	556	688	698	891	901
Padovi pritiska vode	Hlađenje	kPa	12,3	15,4	17,6	19,5	21,4	22,5	23,4	22,5	27,4	27,9	26,2	28,3
	Grejanje	kPa	7,3	8,1	11,7	13,0	21,3	23,0	41,1	43,4	37,8	38,9	42,2	43,3
Nivoi buke		Min-Med-Max dB(A)	24-31-38	25-31-38	30-38-44	31-38-45	26-33-37	27-34-37	34-41-43	35-41-45	39-46-48	40-46-49	42-44-49	42-45-49
Ref. FAN-DECK			C2, A40.6V, [P2-3-5],[NI-2-4]	C3,15, A40.6V, [P2-3-5],[NI-2-4]	C3,15, A80.6V, [P2-3-5],[NI-2-4]	C5, A80.6V, [P2-3-5],[NI-2-4]	C5, A80.6V, [P2-3-5],[NI-2-4]	C3,15, A80.6V, [P2-3-5],[NI-2-4]	C3,15, 5V, [P2-3-4],[ND1-3-4]					
Motori/Ventilatori		No.	1/1	1/1	1/2	1/2	1/2	1/2	1/2	1/2	1/2	1/3	1/3	
Nominalna ulazna struja		MAX. W MAX. A	55 W 0,25 A	80 W 0,35 A	80 W 0,35 A	145 W 0,65 A	180 W 0,80 A	290 W 1,30 A						
Napajanje			230Vac-1Ph-50/60Hz											
Grejno/hladni blok	Zapremina vode	(l)	0,69	0,70	0,99	1,01	1,30	1,31	1,60	1,62	1,91	1,92	2,21	2,23
	[Ranghi], DN(*) - [Rows], DN(*)		[3R], 1/2" F	[3R], 1/2" F	[3R], 1/2" F	[3R], 1/2" F	[3R], 1/2" F	[3R], 1/2" F	[3R], 1/2" F	[3R], 1/2" F	[3R], 1/2" F	[3R], 1/2" F	[3R], 1/2" F	
Grejna spirala	Zapremina vode	(l)	0,23	0,33	0,43	0,54	0,64	0,74						
	[Ranghi], DN(*) - [Rows], DN(*)		[1R], 1/2" F	[1R], 1/2" F	[1R], 1/2" F	[1R], 1/2" F	[1R], 1/2" F							
Odvodna cev		Ø (mm)	20	20	20	20	20	20						
Osnovne dimenzije	L	mm	670	870	1.070	1.270	1.470	1.670						
	H	mm	470	470	470	470	470							
	S	mm	220	220	220	220	220							
	A	mm	400	600	800	1.000	1.200	1.400						
	B	mm	425	625	825	1.025	1.225	1.425						
Donja radna granica	LFI ESP = 0 Pa	Max	1,00	1,00	1,00	1,00	1,00	1,00	1,00	1,00	1,00	1,00	1,00	
		Med	0,78	0,78	0,80	0,80	0,87	0,87	0,88	0,88	0,90	0,90	0,87	0,87
		Min	0,60	0,60	0,62	0,62	0,69	0,70	0,66	0,66	0,69	0,69	0,79	0,79
SMANJENJE PROTOKA VAZDUHA Koefficienti koji definišu dijagrame "Protok vazduha / Statički pritisak" (na 3 brzine Maks-Sred-Min)	15 Pa	Max	0,92	0,92	0,92	0,92	0,92	0,91	0,92	0,92	0,94	0,94	0,96	0,96
		Med	0,69	0,69	0,71	0,71	0,77	0,77	0,80	0,80	0,85	0,85	0,83	0,83
		Min	0,49	0,49	0,52	0,52	0,57	0,57	0,59	0,59	0,65	0,65	0,75	0,75
	30 Pa	Max	0,84	0,84	0,82	0,82	0,81	0,81	0,84	0,84	0,87	0,87	0,91	0,91
		Med	0,60	0,60	0,62	0,62	0,66	0,67	0,71	0,71	0,79	0,79	0,79	0,79
		Min	0,38	0,37	0,42	0,42	0,46	0,46	0,51	0,52	0,59	0,59	0,71	0,71
	45 Pa	Max	0,73	0,73	0,71	0,71	0,69	0,69	0,73	0,73	0,78	0,78	0,82	0,82
		Med	0,48	0,48	0,51	0,51	0,55	0,55	0,62	0,62	0,72	0,72	0,73	0,73
		Min	0,26	0,26	0,29	0,29	0,34	0,34	0,43	0,43	0,53	0,53	0,65	0,65
	60 Pa	Max	0,57	0,57	0,57	0,57	0,58	0,58	0,62	0,62	0,67	0,67	0,73	0,73
		Med	0,36	0,36	0,38	0,38	0,45	0,45	0,51	0,51	0,61	0,61	0,63	0,63
		Min	/	/	/	/	0,23	0,23	0,32	0,32	0,45	0,45	0,56	0,56
	75 Pa	Max	0,38	0,38	0,38	0,38	0,44	0,44	0,50	0,50	0,56	0,56	0,62	0,62
		Med	0,19	0,19	0,20	0,20	0,32	0,32	0,39	0,39	0,49	0,49	0,52	0,52
		Min	/	/	/	/	/	/	0,22	0,23	0,36	0,36	0,47	0,47
Gornja radna granica	LFS	ESP (Pa)	86 Pa	86 Pa	86 Pa	86 Pa	98 Pa	98 Pa	104 Pa	104 Pa	113 Pa	113 Pa	119 Pa	119 Pa
		Qa (x m ³ /h)	x 0,20	x 0,20	x 0,20	x 0,20	x 0,20	x 0,20	x 0,20	x 0,20	x 0,20	x 0,20	x 0,20	x 0,20
	ESP (Pa)	75 Pa	75 Pa	76 Pa	76 Pa	90 Pa	90 Pa	96 Pa	96 Pa	110 Pa	110 Pa	114 Pa	114 Pa	
	Qa (x m ³ /h)	x 0,19	x 0,19	x 0,19	x 0,19	x 0,19	x 0,19	x 0,19	x 0,19	x 0,20	x 0,20	x 0,20	x 0,20	
	ESP (Pa)	57 Pa	57 Pa	57 Pa	57 Pa	69 Pa	69 Pa	80 Pa	80 Pa	99 Pa	99 Pa	112 Pa	112 Pa	
	Qa (x m ³ /h)	x 0,16	x 0,16	x 0,16	x 0,16	x 0,17	x 0,17	x 0,18	x 0,18	x 0,19	x 0,19	x 0,19	x 0,19	

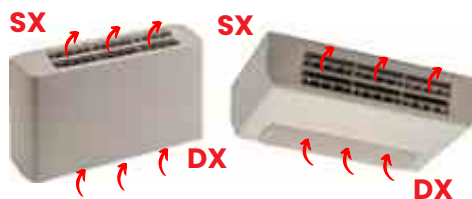

Navedite stranu priključaka za vodu

- SX = Levo (STANDARD)
- DX = Desno

Veličina	FX	131	231	331	431	531	631	731	831	931	1031	1131	1231
Ukupni kapacitet hlađenja	W	1.450	1.940	2.470	2.920	3.650	4.110	5.390	6.230	7.350	8.810	8.840	9.870
Ukupni kapacitet grejanja	W	1.880	1.980	3.180	3.350	4.380	4.550	6.290	6.460	7.990	8.110	10.360	10.480
Protok vazduha	m ³ /h	350	490	490	520	640	680	960	1.000	1.230	1.260	1.670	1.700
Nivo buke	Min-Med-Max dB(A)	24-31-38	25-31-38	30-38-44	31-38-45	26-33-37	27-34-37	34-41-43	35-41-45	39-46-48	40-46-49	42-44-49	42-45-49
VA Vertikalna zidna verzija (osnovna maska)													
	Mod.	FX-VA 131	FX-VA 231	FX-VA 331	FX-VA 431	FX-VA 531	FX-VA 631	FX-VA 731	FX-VA 831	FX-VA 931	FX-VA 1031	FX-VA 1131	FX-VA 1231
	(*) kg	14,4	14,9	17,4	18,2	23,6	24,6	27,2	28,7	31,3	32,8	34,3	37,8
	L x H x S	670 x 520 x 220		870 x 520 x 220		1.070 x 520 x 220		1.270 x 520 x 220		1.470 x 520 x 220		1.670 x 520 x 220	
VB Vertikalna podna verzija (maska s rešetkom za prednje usisavanje vazduha)													
	Mod.	FX-VB 131	FX-VB 231	FX-VB 331	FX-VB 431	FX-VB 531	FX-VB 631	FX-VB 731	FX-VB 831	FX-VB 931	FX-VB 1031	FX-VB 1131	FX-VB 1231
	(*) kg	14,7	15,2	17,9	18,7	24,3	25,3	28,1	29,6	32,4	33,9	35,6	39,1
	L x H x S	670 x 520 x 220		870 x 520 x 220		1.070 x 520 x 220		1.270 x 520 x 220		1.470 x 520 x 220		1.670 x 520 x 220	
VC Vertikalna podna verzija (maska s potporom za usis vazduha na podu + rešetkom)													
	Mod.	FX-VC 131	FX-VC 231	FX-VC 331	FX-VC 431	FX-VC 531	FX-VC 631	FX-VC 731	FX-VC 831	FX-VC 931	FX-VC 1031	FX-VC 1131	FX-VC 1231
	(*) kg	15,9	16,4	19,2	19,8	25,7	26,7	29,6	31,1	34,0	35,5	37,3	40,8
	L x H x S	670 x 675 x 220		870 x 675 x 220		1.070 x 675 x 220		1.270 x 675 x 220		1.470 x 675 x 220		1.670 x 675 x 220	
HA Horizontalna verzija na plafonu (osnovna maska)													
	Mod.	FX-HA 131	FX-HA 231	FX-HA 331	FX-HA 431	FX-HA 531	FX-HA 631	FX-HA 731	FX-HA 831	FX-HA 931	FX-HA 1031	FX-HA 1131	FX-HA 1231
	(*) kg	15,6	16,1	19,0	19,8	25,6	26,6	29,6	31,1	34,1	35,6	37,5	41,1
	L x H x S	670 x 520 x 220		870 x 520 x 220		1.070 x 520 x 220		1.270 x 520 x 220		1.470 x 520 x 220		1.670 x 520 x 220	
HB Horizontalna verzija na plafonu (maska s rešetkom za prednje usisavanje vazduha)													
	Mod.	FX-HB 131	FX-HB 231	FX-HB 331	FX-HB 431	FX-HB 531	FX-HB 631	FX-HB 731	FX-HB 831	FX-HB 931	FX-HB 1031	FX-HB 1131	FX-HB 1231
	(*) kg	15,9	15,5	19,5	20,3	26,3	27,3	30,5	32,0	35,2	36,7	38,8	42,3
	L x H x S	670 x 520 x 220		870 x 520 x 220		1.070 x 520 x 220		1.270 x 520 x 220		1.470 x 520 x 220		1.670 x 520 x 220	
HC Horizontalna verzija na plafonu (maska s potporom za usis vazduha na nogama + rešetkom)													
	Mod.	FX-HC 131	FX-HC 231	FX-HC 331	FX-HC 431	FX-HC 531	FX-HC 631	FX-HC 731	FX-HC 831	FX-HC 931	FX-HC 1031	FX-HC 1131	FX-HC 1231
	(*) kg	17,1	17,6	20,8	21,6	27,7	28,7	32,0	33,5	36,8	38,3	40,5	44,0
	L x H x S	670 x 675 x 220		870 x 675 x 220		1.070 x 675 x 220		1.270 x 675 x 220		1.470 x 675 x 220		1.670 x 675 x 220	

- (*) kg = Neto težina (samo jedinica, bez pakovanja)
- L x H x S = Dužina x Visina x Dubina (dimenzije u mm)

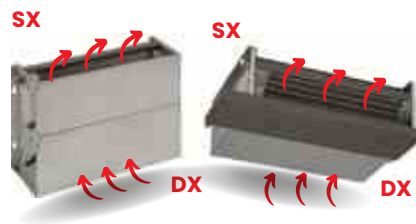

Navedite stranu priključaka za vodu

- SX = Levo (STANDARD)
- DX = Desno

Veličina	FX	131	231	331	431	531	631	731	831	931	1030	1131	1231
Ukupni kapacitet hlađenja	W	1.450	1.940	2.470	2.920	3.650	4.110	5.390	6.230	7.350	8.810	8.840	9.870
Ukupni kapacitet grejanja	W	1.880	1.980	3.180	3.350	4.380	4.550	6.290	6.460	7.990	8.110	10.360	10.480
Protok vazduha	m ³ / h	350	380	480	520	640	680	960	1.000	1.230	1.260	1.670	1.700
Nivo buke	Min-Med-Max dB(A)	24-31-38	25-31-38	30-38-44	31-38-45	26-33-37	27-34-37	34-41-43	35-41-45	39-46-48	40-46-49	42-44-49	42-45-49
CA Vertikalna skrivena verzija (osnovna; bez maske)													
	Mod.	FX-CA 131	FX-CA 231	FX-CA 331	FX-CA 431	FX-CA 531	FX-CA 631	FX-CA 731	FX-CA 831	FX-CA 931	FX-CA 1031	FX-CA 1131	FX-CA 1231
	(*) kg	11,6	12,1	14,5	15,3	20,6	21,6	24,1	25,6	28,1	29,6	31,0	34,5
	L x H x S	450 x 450 x 215		650 x 450 x 215		850 x 450 x 215		1.050 x 450 x 215		1.250 x 450 x 215		1.450 x 450 x 215	
CB Vertikalna skrivena verzija (prednje usisavanje vazduha; bez maske)													
	Mod.	FX-CB 131	FX-CB 231	FX-CB 331	FX-CB 431	FX-CB 531	FX-CB 631	FX-CB 731	FX-CB 831	FX-CB 931	FX-CB 1031	FX-CB 1131	FX-CB 1231
	(*) kg	11,5	12,0	14,4	15,2	20,5	21,5	23,9	25,4	27,9	29,4	30,8	34,3
	L x H x S	450 x 450 x 215		650 x 450 x 215		850 x 450 x 215		1.050 x 450 x 215		1.250 x 450 x 215		1.450 x 450 x 215	
CC Vertikalna skrivena verzija (prednji dovod vazduha; bez maske)													
	Mod.	FX-CC 131	FX-CC 231	FX-CC 331	FX-CC 431	FX-CC 531	FX-CC 631	FX-CC 731	FX-CC 831	FX-CC 931	FX-CC 1031	FX-CC 1131	FX-CC 1231
	(*) kg	12,0	12,5	15,1	15,9	21,4	22,4	25,1	26,6	29,3	30,8	32,4	35,9
	L x H x S	450 x 450 x 215		650 x 450 x 215		850 x 450 x 215		1.050 x 450 x 215		1.250 x 450 x 215		1.450 x 450 x 215	
CD Vertikalna skrivena verzija (prednje usisavanje i dovod vazduha; bez maske)													
	Mod.	FX-CD 131	FX-CD 231	FX-CD 331	FX-CD 431	FX-CD 531	FX-CD 631	FX-CD 731	FX-CD 831	FX-CD 931	FX-CD 1031	FX-CD 1131	FX-CD 1231
	(*) kg	11,9	12,4	15,0	15,8	21,3	22,3	24,9	26,4	29,1	30,6	32,2	35,7
	L x H x S	450 x 450 x 215		650 x 450 x 215		850 x 450 x 215		1.050 x 450 x 215		1.250 x 450 x 215		1.450 x 450 x 215	
CH Horizontalna skrivena verzija (osnovna; bez ormara) - Ugaono nagnuto filtriranje prema dole, usis vazduha NIJE kanaliziran													
	Mod.	FX-CH 131	FX-CH 231	FX-CH 331	FX-CH 431	FX-CH 531	FX-CH 631	FX-CH 731	FX-CH 831	FX-CH 931	FX-CH 1031	FX-CH 1131	FX-CH 1231
	(*) kg	12,0	12,5	14,9	15,7	21,0	22,0	24,5	26,0	28,5	30,0	31,4	34,9
	L x H x S	545 x 450 x 215		745 x 450 x 215		945 x 450 x 215		1.145 x 450 x 215		1.345 x 450 x 215		1.545 x 450 x 215	
CK Horizontalna skrivena verzija (prednje usisavanje vazduha; bez maske)													
	Mod.	FX-CK 131	FX-CK 231	FX-CK 331	FX-CK 431	FX-CK 531	FX-CK 631	FX-CK 731	FX-CK 831	FX-CK 931	FX-CK 1031	FX-CK 1131	FX-CK 1231
	(*) kg	11,9	12,4	14,8	15,6	20,9	21,9	24,3	25,8	28,3	29,8	31,2	34,7
	L x H x S	545 x 450 x 215		745 x 450 x 215		945 x 450 x 215		1.145 x 450 x 215		1.345 x 450 x 215		1.545 x 450 x 215	
CS Horizontalna skrivena verzija (osnovna; bez ormara) - Vertikalno filtriranje dole, usis vazduha kanaliziran													
	Mod.	FX-CS 130	FX-CS 230	FX-CS 331	FX-CS 431	FX-CS 531	FX-CS 631	FX-CS 731	FX-CS 831	FX-CS 931	FX-CS 1031	FX-CS 1131	FX-CS 1231
	(*) kg	12,1	12,6	15,0	15,8	21,1	22,1	24,6	26,1	28,6	30,1	31,5	35,0
	L x H x S	545 x 450 x 215		745 x 450 x 215		945 x 450 x 215		1.145 x 450 x 215		1.345 x 450 x 215		1.545 x 450 x 215	
CT Horizontalna skrivena verzija (osnovna; bez maske) - Vertikalno filtriranje prema gore, usis vazduha kanaliziran													
	Mod.	FX-CT 131	FX-CT 231	FX-CT 331	FX-CT 431	FX-CT 531	FX-CT 631	FX-CT 731	FX-CT 831	FX-CT 931	FX-CT 1031	FX-CT 1130	FX-CT 1230
	(*) kg	12,1	12,6	15,0	15,8	21,1	22,1	24,6	26,1	28,6	30,1	31,5	35,0
	L x H x S	545 x 450 x 215		745 x 450 x 215		945 x 450 x 215		1.145 x 450 x 215		1.345 x 450 x 215		1.545 x 450 x 215	

- (*) kg = Neto težina (samo jedinica, bez pakovanja)
- L x H x S = Dužina x Visina x Dubina (dimenzije u mm)



FX-P(VA)

AC Električni Motor

Karakteristike:

- Tip: Asinhroni jednofazni motor.
- Zaštita: TH (Klixon) termička zaštita, stalno aktivan radni kondenzator.
- Specifikacije: 4 pola, IP42, Klasa B, dvostruka izolacija, 230Vac-1Ph-50/60Hz.

Modeli:

- Manji: Jednobrinski motor + autotransformator sa 6 brzina.
- Veći: 5 ili 6 brzina direktno na motoru, sa fabrički podešenim srednjim brzinama.

Prilagodljivost:

Po zahtevu, prilagodavanje brzine bez dodatnih troškova, za optimizaciju performansi.

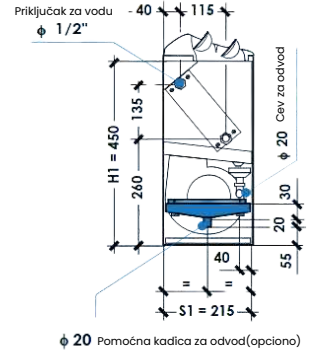
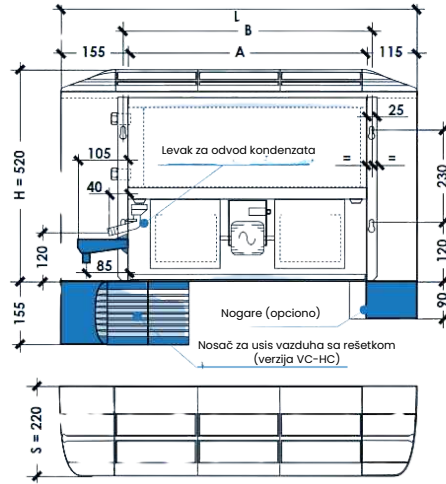

Verzija sa maskom
H = 520 mm
S = 220 mm



Nominalni tehnički podaci (jedinice za dvocevni sistem sa standardnim AC motorom)

Veličina		FX-P	130P	230P	330P	430P	530P	630P	730P	830P	930P	1030P	1130P	1230P
Kapacitet hlađenja	Total	W	1.590	2.180	2.740	3.180	3.950	4.460	5.850	6.790	8.140	9.820	9.600	10.710
	Senzibilni	W	1.380	1.790	2.270	2.450	3.050	3.420	4.630	5.120	6.200	7.300	7.640	8.360
Kapacitet grejanja		W	4.000	5.380	6.510	7.100	8.630	9.950	12.770	14.120	16.830	19.790	21.100	23.200
Nominalni protok vazduha		m3/h	410	460	570	600	730	780	1.100	1.150	1.450	1.500	1.910	1.940
Protok vode	Hlađenje	l/h	273	375	471	547	679	767	1.006	1.168	1.400	1.689	1.651	1.842
	Grejanje	l/h	344	463	560	611	742	856	1.098	1.214	1.447	1.702	1.815	1.995
Padovi pritiska vode	Hlađenje	kPa	14,7	19,4	21,6	23,0	25,1	26,5	27,5	30,3	33,7	34,6	31,0	33,4
	Grejanje	kPa	18,1	23,0	23,8	22,3	23,4	25,8	25,6	25,6	28,0	27,4	29,2	30,6
Nivoi buke		Min-Med-Max dB(A)	29-36-39	30-38-42	41-44-45	42-45-47	25-32-37	27-34-39	37-43-47	38-44-48	43-48-51	44-49-52	45-48-51	46-48-51
Ref. FAN-DECK			C3,15, A40,6V, [P2-3-5], [NI-2-4]	C3,15, A80,6V, [P2-3-5], [NI-2-4]	C2, A80,6V, [P2-3-5], [NI-2-4]	C4, A80,6V, [P2-3-5], [NI-2-4]	C4, 6V, [P2-3-4], [NI-3-5]	C4, 5V, [P2-3-4], [NI-3-4]						
Motori/Ventilatori		No.	1/1		1/1		1/2		1/2		1/2		1/3	
Nominalna ulazna struja	MAX	W	55 W		125 W		115 W		195 W		230 W		290 W	
	MAX	A	0,25 A		0,55 A		0,50 A		0,85 A		1,00 A		1,30 A	
Napajanje 230Vac-1Ph-50/60Hz														
Grejno/hladni blok	Zapremina vode	(l)	0,69	0,70	0,99	1,01	1,30	1,31	1,60	1,62	1,91	1,92	2,21	2,23
	[Ranghi], DN(*) - [Rows], DN(*)		[3R], 1/2" F		[3R], 1/2" F		[3R], 1/2" F		[3R], 1/2" F		[3R], 1/2" F		[3R], 1/2" F	
Odvodna cev		Ø	20		20		20		20		20		20	
Osnovne dimenzije	L	(mm)	670		870		1.070		1.270		1.470		1.670	
	H	mm	470		470		470		470		470		470	
	S	mm	220		220		220		220		220		220	
	A	mm	400		600		800		1.000		1.200		1.400	
Donja radna granica	LFI ESP = 0 Pa	Max	1,00	1,00	1,00	1,00	1,00	1,00	1,00	1,00	1,00	1,00	1,00	1,00
		Med	0,88	0,87	0,95	0,93	0,86	0,86	0,90	0,90	0,89	0,89	0,86	0,86
SMANJENJE PROTOKA VAZDUHA Koefficienti koji definišu dijagrame "Protok vazduha / Statički pritisak" (na 3 brzine Maks-Sred-Min)	15 Pa	Min	0,68	0,67	0,84	0,83	0,65	0,66	0,68	0,69	0,68	0,68	0,78	0,78
		Max	0,94	0,94	0,98	0,96	0,93	0,93	0,95	0,95	0,96	0,96	0,95	0,95
		Med	0,78	0,78	0,93	0,92	0,78	0,78	0,86	0,86	0,83	0,83	0,82	0,82
	30 Pa	Min	0,55	0,54	0,82	0,82	0,54	0,55	0,65	0,66	0,65	0,65	0,73	0,73
		Max	0,86	0,86	0,94	0,92	0,85	0,85	0,89	0,89	0,90	0,90	0,90	0,90
		Med	0,68	0,67	0,89	0,88	0,69	0,69	0,80	0,81	0,76	0,76	0,78	0,78
	45 Pa	Min	0,43	0,42	0,77	0,76	0,44	0,45	0,61	0,62	0,60	0,60	0,60	0,70
		Max	0,76	0,76	0,87	0,86	0,74	0,74	0,82	0,82	0,83	0,83	0,83	0,83
		Med	0,56	0,55	0,79	0,78	0,59	0,59	0,73	0,74	0,69	0,69	0,72	0,72
	60 Pa	Min	0,30	0,30	0,66	0,66	0,36	0,36	0,54	0,55	0,55	0,55	0,64	0,64
		Max	0,61	0,61	0,74	0,74	0,61	0,61	0,71	0,71	0,73	0,73	0,73	0,73
		Med	0,42	0,41	0,68	0,67	0,74	0,74	0,63	0,64	0,60	0,60	0,63	0,63
	75 Pa	Min	0,17	0,17	0,55	0,54	0,27	0,36	0,44	0,44	0,48	0,48	0,56	0,56
		Max	0,41	0,41	0,59	0,59	0,45	0,45	0,57	0,57	0,61	0,61	0,62	0,62
		Med	0,23	0,23	0,54	0,53	0,34	0,34	0,49	0,49	0,50	0,50	0,52	0,52
	90 Pa	Min	/	/	0,41	0,41	0,17	0,17	0,32	0,32	0,37	0,37	0,46	0,46
		Max	/	/	0,39	0,39	0,31	0,31	0,38	0,38	0,47	0,47	0,47	0,47
		Med	/	/	0,37	0,36	/	/	0,31	0,31	0,38	0,38	0,37	0,37
LFS Gornja radna granica	ESP (Pa) Qa (x m3/h)	Max	87 Pa x 0,20	87 Pa x 0,20	105 Pa x 0,20	105 Pa x 0,20	100 Pa x 0,20	100 Pa x 0,20	103 Pa x 0,20	103 Pa x 0,20	115 Pa x 0,20	115 Pa x 0,20	119 Pa x 0,20	119 Pa x 0,20
		Med	78 Pa x 0,19	78 Pa x 0,19	102 Pa x 0,20	102 Pa x 0,20	89 Pa x 0,19	89 Pa x 0,19	99 Pa x 0,20	99 Pa x 0,20	108 Pa x 0,19	108 Pa x 0,19	113 Pa x 0,19	113 Pa x 0,19
		Min	60 Pa x 0,17	60 Pa x 0,17	93 Pa x 0,19	93 Pa x 0,19	75 Pa x 0,17	75 Pa x 0,17	91 Pa x 0,19	91 Pa x 0,19	98 Pa x 0,18	98 Pa x 0,18	111 Pa x 0,19	111 Pa x 0,19

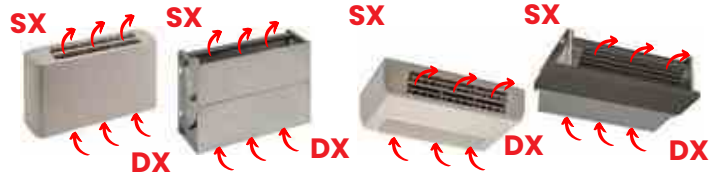

Navedite stranu priključaka za vodu

- SX = Levo (STANDARD)
- DX = Desno

Veličina	FX-P	130P	230P	330P	430P	530P	630P	730P	830P	930P	1030P	1130P	1230P
Ukupni kapacitet hlađenja	W	1.590	2.180	2.740	3.180	3.950	4.460	5.850	6.790	8.140	9.820	9.600	10.710
Ukupni kapacitet grejanja	W	4.000	5.380	6.510	7.100	8.630	9.950	12.770	14.120	16.830	19.790	21.100	23.200
Protok vazduha	m ³ /h	410	460	570	600	730	780	1.100	1.150	1.450	1.500	1.910	1.940
Nivo buke	Min-Med-Max dB(A)	29-36-39	30-38-42	41-44-45	42-45-47	25-32-37	27-34-39	37-43-47	38-44-48	43-48-51	44-49-52	45-48-51	46-48-51
VA Vertikalna verzija za montažu na zid (osnovna maska)													
	Mod.	FX-VA 130P	FX-VA 230P	FX-VA 330P	FX-VA 430P	FX-VA 530P	FX-VA 630P	FX-VA 730P	FX-VA 830P	FX-VA 930P	FX-VA 1030P	FX-VA 1130P	FX-VA 1230P
	(*) kg	14,1	14,6	17,2	18,0	23,0	24,0	26,9	28,4	31,1	32,6	34,0	37,5
	L x H x S	670 x 520 x 220		870 x 520 x 220		1.070 x 520 x 220		1.270 x 520 x 220		1.470 x 520 x 220		1.670 x 520 x 220	
VB Vertikalna verzija za montažu na pod (maska sa rešetkom za usis vazduha sa prednje strane)													
	Mod.	FX-VB 130P	FX-VB 230P	FX-VB 330P	FX-VB 430P	FX-VB 530P	FX-VB 630P	FX-VB 730P	FX-VB 830P	FX-VB 930P	FX-VB 1030P	FX-VB 1130P	FX-VB 1230P
	(*) kg	14,2	14,9	17,7	18,5	23,7	24,7	27,8	29,3	32,2	33,7	35,3	38,8
	L x H x S	670 x 520 x 220		870 x 520 x 220		1.070 x 520 x 220		1.270 x 520 x 220		1.470 x 520 x 220		1.670 x 520 x 220	
HA Horizontalna verzija za plafonsku montažu (osnovna maska)													
	Mod.	FX-HA 130P	FX-HA 230P	FX-HA 330P	FX-HA 430P	FX-HA 530P	FX-HA 630P	FX-HA 730P	FX-HA 830P	FX-HA 930P	FX-HA 1030P	FX-HA 1130P	FX-HA 1230P
	(*) kg	15,3	15,8	19,8	19,6	25,0	26,0	29,3	30,8	33,9	35,4	37,2	40,7
	L x H x S	670 x 520 x 220		870 x 520 x 220		1.070 x 520 x 220		1.270 x 520 x 220		1.470 x 520 x 220		1.670 x 520 x 220	
HB Horizontalna verzija za plafonsku montažu (maska sa rešetkom za usis vazduha sa prednje strane)													
	Mod.	FX-HB 130P	FX-HB 230P	FX-HB 330P	FX-HB 430P	FX-HB 530P	FX-HB 630P	FX-HB 730P	FX-HB 830P	FX-HB 930P	FX-HB 1030P	FX-HB 1130P	FX-HB 1230P
	(*) kg	15,6	16,1	19,3	20,1	25,7	26,7	30,2	31,7	35,0	36,5	38,5	42,0
	L x H x S	450 x 450 x 215		650 x 450 x 215		850 x 450 x 215		1.050 x 450 x 215		1.250 x 450 x 215		1.450 x 450 x 215	
CA Vertikalna ugradna verzija (osnovna; bez maske)													
	Mod.	FX-CA 130P	FX-CA 230P	FX-CA 330P	FX-CA 430P	FX-CA 530P	FX-CA 630P	FX-CA 730P	FX-CA 830P	FX-CA 930P	FX-CA 1030P	FX-CA 1130P	FX-CA 1230P
	(*) kg	11,3	11,8	14,3	15,1	20,0	21,0	23,8	25,3	27,9	29,4	30,7	34,2
	L x H x S	670 x 520 x 220		870 x 520 x 220		1.070 x 520 x 220		1.270 x 520 x 220		1.250 x 450 x 215		1.670 x 520 x 220	
CB Vertikalna ugradna verzija (usis vazduha sa prednje strane; bez maske)													
	Mod.	FX-CB 130P	FX-CB 230P	FX-CB 330P	FX-CB 430P	FX-CB 530P	FX-CB 630P	FX-CB 730P	FX-CB 830P	FX-CB 930P	FX-CB 1030P	FX-CB 1130P	FX-CB 1230P
	(*) kg	11,2	11,7	14,2	15,0	19,9	20,9	23,6	25,1	27,7	29,2	30,5	34,0
	L x H x S	450 x 450 x 215		650 x 450 x 215		850 x 450 x 215		1.050 x 450 x 215		1.250 x 450 x 215		1.450 x 450 x 215	
CH Horizontalna ugradna verzija (osnovna; bez maske) - Kosno nadole izvlačenje filtera, usis vazduha NIJE za kanalisanje													
	Mod.	FX-CH 130P	FX-CH 230P	FX-CH 330P	FX-CH 430P	FX-CH 530P	FX-CH 630P	FX-CH 730P	FX-CH 830P	FX-CH 930P	FX-CH 1030P	FX-CH 1130P	FX-CH 1230P
	(*) kg	11,7	12,2	14,7	15,5	20,4	21,4	24,2	25,7	28,3	29,8	31,1	34,6
	L x H x S	545 x 450 x 215		745 x 450 x 215		945 x 450 x 215		1.145 x 450 x 215		1.345 x 450 x 215		1.545 x 450 x 215	
CK Horizontalna ugradna verzija (usis vazduha sa prednje strane; bez maske)													
	Mod.	FX-CK 130P	FX-CK 230P	FX-CK 330P	FX-CK 430P	FX-CK 530P	FX-CK 630P	FX-CK 730P	FX-CK 830P	FX-CK 930P	FX-CK 1030P	FX-CK 1130P	FX-CK 1230P
	(*) kg	11,6	12,1	14,6	15,4	20,3	21,3	24,0	25,5	28,1	29,6	30,9	34,4
	L x H x S	545 x 450 x 215		745 x 450 x 215		945 x 450 x 215		1.145 x 450 x 215		1.345 x 450 x 215		1.545 x 450 x 215	

- (*) kg = Neto težina (samo jedinica, bez pakovanja)
- L x H x S = Dužina x Visina x Dubina (dimenzije u mm)

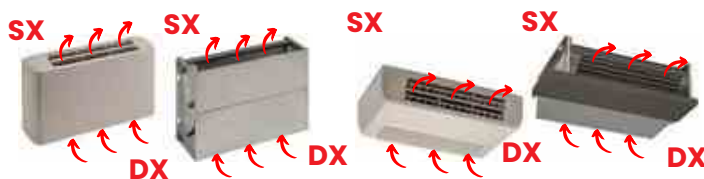

Navedite stranu priključaka za vodu

- SX = Levo (STANDARD)
- DX = Desno

Veličina	FX-P	131P	231P	331P	431P	531P	631P	731P	831P	931P	1031P	1131P	1231P
Ukupni kapacitet hlađenja	W	1.550	2.120	2.680	3.150	3.890	4.330	5.710	6.640	7.970	9.620	9.420	10.510
Ukupni kapacitet grejanja	W	2.010	2.180	3.470	3.640	4.690	4.810	6.690	6.910	8.700	8.900	11.090	11.200
Protok vazduha	m ³ /h	390	440	550	590	710	740	1.055	1.110	1.400	1.450	1.850	1.880
Nivo buke	Min-Med-Max dB(A)	29-36-39	30-38-42	41-44-45	42-45-47	25-32-37	27-34-39	37-43-47	38-44-48	43-48-51	44-49-52	45-48-51	46-48-51
VA Vertikalna verzija za montažu na zid (osnovna maska)													
	Mod.	FX-VA 131P	FX-VA 231P	FX-VA 331P	FX-VA 431P	FX-VA 531P	FX-VA 631P	FX-VA 731P	FX-VA 831P	FX-VA 931P	FX-VA 1031P	FX-VA 1131P	FX-VA 1231P
	(*) kg	15,0	15,5	18,2	19,0	24,1	25,1	28,1	29,6	32,4	33,9	35,4	38,9
	L x H x S	670 x 520 x 220	670 x 520 x 220	870 x 520 x 220	870 x 520 x 220	1.070 x 520 x 220	1.070 x 520 x 220	1.270 x 520 x 220	1.270 x 520 x 220	1.470 x 520 x 220	1.470 x 520 x 220	1.670 x 520 x 220	1.670 x 520 x 220
VB Vertikalna verzija za montažu na pod (maska sa rešetkom za usis vazduha sa prednje strane)													
	Mod.	FX-VB 131P	FX-VB 231P	FX-VB 331P	FX-VB 431P	FX-VB 531P	FX-VB 631P	FX-VB 731P	FX-VB 831P	FX-VB 931P	FX-VB 1031P	FX-VB 1131P	FX-VB 1231P
	(*) kg	15,3	15,8	18,7	19,5	24,8	25,8	29,0	30,5	33,5	35,0	36,7	40,2
	L x H x S	670 x 520 x 220	670 x 520 x 220	870 x 520 x 220	870 x 520 x 220	1.070 x 520 x 220	1.070 x 520 x 220	1.270 x 520 x 220	1.270 x 520 x 220	1.470 x 520 x 220	1.470 x 520 x 220	1.670 x 520 x 220	1.670 x 520 x 220
HA Horizontalna verzija za plafonsku montažu (osnovna maska)													
	Mod.	FX-HA 131P	FX-HA 231P	FX-HA 331P	FX-HA 431P	FX-HA 531P	FX-HA 631P	FX-HA 731P	FX-HA 831P	FX-HA 931P	FX-HA 1031P	FX-HA 1131P	FX-HA 1231P
	(*) kg	16,2	16,7	19,8	20,6	26,1	27,1	30,5	32,0	35,2	36,7	38,6	42,1
	L x H x S	670 x 520 x 220	670 x 520 x 220	870 x 520 x 220	870 x 520 x 220	1.070 x 520 x 220	1.070 x 520 x 220	1.270 x 520 x 220	1.270 x 520 x 220	1.470 x 520 x 220	1.470 x 520 x 220	1.670 x 520 x 220	1.670 x 520 x 220
HB Horizontalna verzija za plafonsku montažu (maska sa rešetkom za usis vazduha sa prednje strane)													
	Mod.	FX-HB 131P	FX-HB 231P	FX-HB 331P	FX-HB 431P	FX-HB 531P	FX-HB 631P	FX-HB 731P	FX-HB 831P	FX-HB 931P	FX-HB 1031P	FX-HB 1131P	FX-HB 1231P
	(*) kg	16,5	17,0	20,3	21,1	26,8	27,8	31,4	32,9	36,3	37,8	39,9	43,4
	L x H x S	670 x 520 x 220	670 x 520 x 220	870 x 520 x 220	870 x 520 x 220	1.070 x 520 x 220	1.070 x 520 x 220	1.050 x 450 x 215	1.050 x 450 x 215	1.470 x 520 x 220	1.470 x 520 x 220	1.670 x 520 x 220	1.670 x 520 x 220
CA Vertikalna ugradna verzija (osnovna; bez maske)													
	Mod.	FX-CA 131P	FX-CA 231P	FX-CA 331P	FX-CA 431P	FX-CA 531P	FX-CA 631P	FX-CA 731P	FX-CA 831P	FX-CA 931P	FX-CA 1031P	FX-CA 1131P	FX-CA 1231P
	(*) kg	12,2	12,7	15,3	16,1	21,1	22,1	25,0	26,5	29,2	30,7	32,1	35,6
	L x H x S	450 x 450 x 215	450 x 450 x 215	650 x 450 x 215	650 x 450 x 215	850 x 450 x 215	850 x 450 x 215	1.050 x 450 x 215	1.050 x 450 x 215	1.250 x 450 x 215	1.250 x 450 x 215	1.450 x 520 x 220	1.450 x 520 x 220
CB Vertikalna ugradna verzija (usis vazduha sa prednje strane; bez maske)													
	Mod.	FX-CB 131P	FX-CB 231P	FX-CB 331P	FX-CB 431P	FX-CB 531P	FX-CB 631P	FX-CB 731P	FX-CB 831P	FX-CB 931P	FX-CB 1031P	FX-CB 1131P	FX-CB 1231P
	(*) kg	12,1	12,6	15,2	16,0	21,0	22,0	24,8	26,3	29,0	30,5	31,9	35,4
	L x H x S	450 x 450 x 215	450 x 450 x 215	650 x 450 x 215	650 x 450 x 215	850 x 450 x 215	850 x 450 x 215	1.050 x 450 x 215	1.050 x 450 x 215	1.250 x 450 x 215	1.250 x 450 x 215	1.450 x 450 x 215	1.450 x 450 x 215
CH Horizontalna ugradna verzija (osnovna; bez maske) - Kosno nadole izvlačenje filtera, usis vazduha NIJE za kanalsanje													
	Mod.	FX-CH 131P	FX-CH 231P	FX-CH 331P	FX-CH 431P	FX-CH 531P	FX-CH 631P	FX-CH 731P	FX-CH 831P	FX-CH 931P	FX-CH 1031P	FX-CH 1131P	FX-CH 1231P
	(*) kg	12,6	13,1	15,7	16,5	21,5	22,5	25,4	26,9	29,6	31,1	32,5	36,0
	L x H x S	545 x 450 x 215	545 x 450 x 215	745 x 450 x 215	745 x 450 x 215	945 x 450 x 215	945 x 450 x 215	1.145 x 450 x 215	1.145 x 450 x 215	1.345 x 450 x 215	1.345 x 450 x 215	1.545 x 450 x 215	1.545 x 450 x 215
CK Vertikalna ugradna verzija (usis vazduha sa prednje strane; bez maske)													
	Mod.	FX-CK 131P	FX-CK 231P	FX-CK 331P	FX-CK 431P	FX-CK 531P	FX-CK 631P	FX-CK 731P	FX-CK 831P	FX-CK 931P	FX-CK 1031P	FX-CK 1131P	FX-CK 1231P
	(*) kg	12,5	13,0	15,6	16,4	21,4	22,4	25,2	26,7	29,4	30,9	32,3	35,8
	L x H x S	545 x 450 x 215	545 x 450 x 215	745 x 450 x 215	745 x 450 x 215	945 x 450 x 215	945 x 450 x 215	1.145 x 450 x 215	1.145 x 450 x 215	1.345 x 450 x 215	1.345 x 450 x 215	1.545 x 450 x 215	1.545 x 450 x 215

- (*) kg = Neto težina (samo jedinica, bez pakovanja)
- D x V x Š = Dužina x Visina x Dubina (dimenzije u mm)



FX-S(VA)

Super-tihi fan coil:

Dizajniran za one koji žele tišinu i udobnost. Idealan za spavaće sobe, luksuzne prostore i tihe radne sredine. Opremljen tehnologijom za smanjenje buke, uključuje:

- Asinhroni motor sa termičkom zaštitom, 230Vac, jednofazni.
- Motor sa jednom brzinom i autotransformatorom za lako održavanje.
- Prilagodljive brzine, tihi rad, pojačana termo-akustička i antivibraciona izolacija.
- Napredno testiranje za maksimalno smanjenje buke i vibracija.

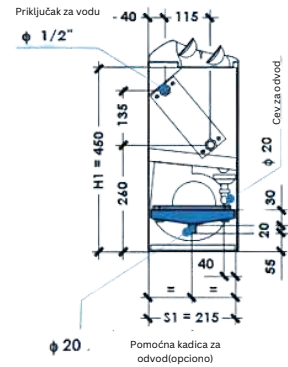
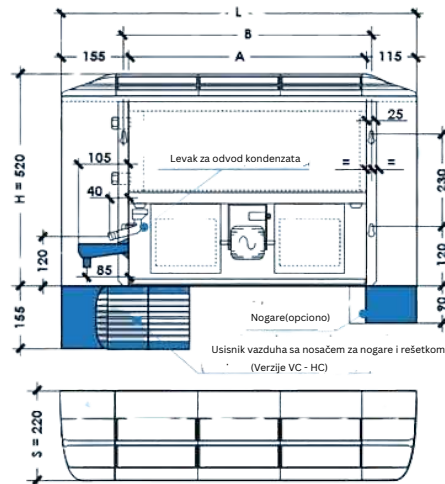

Verzija sa maskom H = 520 mm S = 220 mm
Verzija bez maske H1 = 450 mm S1 = 215 mm



Nominalni tehnički podaci (jedinice za dvocevni sistem sa AC motorom)

Veličina		FX-S	130S	230S	330S	430S	530S	630S	730S	830S	930S	1030S	1130S	1230S	
Kapacitet hlađenja	Total	W	1.030	1.390	1.810	2.160	2.690	3.050	3.900	4.590	4.860	5.960	6.020	6.790	
	Senzibilni	W	840	1.060	1.410	1.570	1.950	2.200	2.900	3.260	3.420	4.100	4.460	4.940	
Kapacitet grejanja		W	2.500	3.320	4.180	4.700	5.720	6.620	8.290	9.300	9.720	11.640	12.850	14.290	
Nominalni protok vazduha		m ³ /h	200	220	290	320	390	420	570	610	630	670	900	930	
Protok vode	Hlađenje	l/h	177	239	311	372	463	525	671	789	836	1.025	1.035	1.168	
	Grejanje	l/h	215	286	359	404	492	569	713	800	836	1.001	1.105	1.229	
Padovi pritiska vode	Hlađenje	kPa	6,2	7,9	9,4	10,6	11,6	12,4	12,2	13,8	12,	12,7	12,2	13,4	
	Grejanje	kPa	7,1	8,7	9,8	9,8	10,3	11,4	10,8	11,1	9,4	9,5	10,8	11,6	
Nivoi buke		Min-Med-Max dB(A)	<10-11-16	<10-11-16	14-16-22	14-16-22	12-13-18	12-13-18	17-19-25	17-19-25	15-18-24	15-18-24	16-21-26	16-21-26	
Ref. FAN-DECK			C1,5, A40,6V, [P4-5-6], [N4-5-6]	C2,5, A40,6V, [P4-5-6], [N4-5-6]	C2,5, A40,6V, [P4-5-6], [N4-5-6]	C2,5, A80,6V, [P4-5-6], [N4-5-6]	C4, A80,6V, [P4-5-6], [N4-5-6]	C4, A80,6V, [P4-5-6], [N4-5-6]	C2,5, A80,6V, [P4-5-6], [N4-5-6]	C4, V3-A240, [P4-5-6], [N4-5-6]	C4, V3-A240, [P4-5-6], [N4-5-6]	C4, V3-A240, [P4-5-6], [N4-5-6]	C4, V3-A240, [P4-5-6], [N4-5-6]	C4, V3-A240, [P4-5-6], [N4-5-6]	
Motori/Ventilatori		No.	1/1		1/1		1/2		1/2		1/2		1/3		
Nominalna ulazna struja		MAX W	55 W		80 W		80 W		145 W		180 W		290 W		
		MAX A	0,25 A		0,35 A		0,35 A		0,65 A		0,80 A		1,30 A		
Napajanje			230Vac-1Ph-50/60Hz												
Grejno/hladni blok		Zapremina vode (l)	0,69	0,70	0,99	1,01	1,30	1,31	1,60	1,62	1,91	1,92	2,21	2,23	
		[Ranghi], DN(*) - [Rows], DN(*)	[3R], 1/2" F		[3R], 1/2" F		[3R], 1/2" F		[3R], 1/2" F		[3R], 1/2" F		[3R], 1/2" F		
Odvodna cev		Ø φ (mm)	20		20		20		20		20		20		
Osnovne dimenzije		L mm	670		870		1.070		1.270		1.470		1.670		
		H mm	470		470		470		470		470		470		
		S mm	220		220		220		220		220		220		
		A mm	400		600		800		1.000		1.200		1.400		
B mm			425		625		825		1.025		1.225		1.425		
Donja radna granica		LFI	1,00	1,00	1,00	1,00	1,00	1,00	1,00	1,00	1,00	1,00	1,00	1,00	
		ESP = 0 Pa	0,75	0,77	0,76	0,75	0,79	0,81	0,79	0,79	0,76	0,76	0,82	0,83	
			0,60	0,64	0,66	0,66	0,72	0,74	0,70	0,70	0,67	0,67	0,68	0,68	
SMANJENJE PROTOKA VAZDUHA Koefficienti koji definišu dijagrame "Protok vazduha / Statički pritisak" (na 3 brzine Maks-Sred-Min)		15 Pa	Max	0,81	0,81	0,84	0,84	0,81	0,21	0,87	0,87	0,91	0,91	0,94	0,94
			Med	0,53	0,55	0,59	0,59	0,57	0,58	0,61	0,61	0,66	0,66	0,78	0,79
			Min	0,30	0,32	0,39	0,39	0,47	0,48	0,49	0,50	0,55	0,55	0,64	0,64
		30 Pa	Max	0,61	0,61	0,67	0,67	0,61	0,61	0,73	0,73	0,80	0,80	0,88	0,88
			Med	0,36	0,37	0,43	0,42	0,39	0,37	0,44	0,44	0,55	0,55	0,73	0,74
			Min	/	0,06	0,14	0,14	0,26	0,27	0,35	0,35	0,43	0,44	0,59	0,59
45 Pa	Max	0,42	0,42	0,47	0,47	0,42	0,42	0,58	0,58	0,66	0,66	0,80	0,80		
	Med	/	/	0,26	0,26	0,19	0,19	0,30	0,30	0,43	0,43	0,67	0,67		
	Min	/	/	/	/	/	/	0,22	0,22	0,32	0,32	0,53	0,53		
LFS Gornja radna granica		ESP (Pa)	60 Pa	60 Pa	60 Pa	60 Pa	63 Pa	63 Pa	75 Pa	75 Pa	78 Pa	78 Pa	99 Pa	99 Pa	
		Qa (x m ³ /h)	x 0,20	x 0,20	x 0,20	x 0,20	x 0,20	x 0,20	x 0,20	x 0,20	x 0,20	x 0,20	x 0,20	x 0,20	
		Med	44 Pa	44 Pa	51 Pa	51 Pa	47 Pa	47 Pa	60 Pa	60 Pa	72 Pa	72 Pa	94 Pa	94 Pa	
		ESP (Pa)	x 0,17	x 0,17	x 0,18	x 0,18	x 0,17	x 0,17	x 0,16	x 0,16	x 0,19	x 0,19	x 0,19	x 0,19	
		Qa (x m ³ /h)	x 0,13	x 0,13	x 0,14	x 0,14	x 0,16	x 0,16	x 0,16	x 0,16	x 0,18	x 0,18	x 0,19	x 0,19	

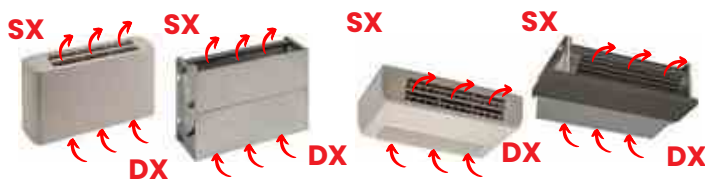

Navedite stranu priključaka za vodu

- SX = Levo (STANDARD)
- DX = Desno

Veličina	FX-S	130S	230S	330S	430S	530S	630S	730S	830S	930S	1030S	1130S	1230S
Ukupni kapacitet hlađenja	W	1.030	1.390	1.810	2.160	2.690	3.050	3.900	4.590	4.860	5.960	6.020	6.790
Ukupni kapacitet grejanja	W	2.500	3.320	4.180	4.700	5.720	6.620	8.290	9.300	9.720	11.640	12.850	14.290
Protok vazduha	m ³ /h	200	220	290	320	390	420	570	610	630	670	900	930
Nivo buke	Min-Med-Max dB(A)	<10-11-16	<10-11-16	14-16-22	14-16-22	12-13-18	12-13-18	17-19-25	17-19-25	15-18-24	15-18-24	16-21-26	16-21-26
VA Vertikalna verzija za montažu na zid (osnovna maska)													
	Mod.	FX-VA 130S	FX-VA 230S	FX-VA 330S	FX-VA 430S	FX-VA 530S	FX-VA 630S	FX-VA 730S	FX-VA 830S	FX-VA 930S	FX-VA 1030S	FX-VA 1130S	FX-VA 1230S
	(*) kg	14,2	14,7	17,1	17,9	23,2	24,2	26,7	28,2	30,7	32,2	33,6	37,1
	L x H x S	670 x 520 x 220	670 x 520 x 220	870 x 520 x 220	870 x 520 x 220	1.070 x 520 x 220	1.070 x 520 x 220	1.270 x 520 x 220	1.270 x 520 x 220	1.470 x 520 x 220	1.470 x 520 x 220	1.670 x 520 x 220	1.670 x 520 x 220
VB Vertikalna verzija za montažu na pod (maska sa rešetkom za usis vazduha sa prednje strane)													
	Mod.	FX-VB 130S	FX-VB 230S	FX-VB 330S	FX-VB 430S	FX-VB 530S	FX-VB 630S	FX-VB 730S	FX-VB 830S	FX-VB 930S	FX-VB 1030S	FX-VB 1130S	FX-VB 1230S
	(*) kg	14,5	15,0	17,6	18,4	23,9	24,9	27,6	29,1	32,2	33,3	34,9	38,4
	L x H x S	670 x 520 x 220	670 x 520 x 220	870 x 520 x 220	870 x 520 x 220	1.070 x 520 x 220	1.070 x 520 x 220	1.270 x 520 x 220	1.270 x 520 x 220	1.470 x 520 x 220	1.470 x 520 x 220	1.670 x 520 x 220	1.670 x 520 x 220
HA Horizontalna verzija za plafonsku montažu (osnovna maska)													
	Mod.	FX-HA 130S	FX-HA 230S	FX-HA 330S	FX-HA 430S	FX-HA 530S	FX-HA 630S	FX-HA 730S	FX-HA 830S	FX-HA 930S	FX-HA 1030S	FX-HA 1130S	FX-HA 1230S
	(*) kg	15,4	15,9	18,7	19,5	25,2	26,2	29,1	30,6	33,5	35,0	36,8	40,3
	L x H x S	670 x 520 x 220	670 x 520 x 220	870 x 520 x 220	870 x 520 x 220	1.070 x 520 x 220	1.070 x 520 x 220	1.270 x 520 x 220	1.270 x 520 x 220	1.470 x 520 x 220	1.470 x 520 x 220	1.670 x 520 x 220	1.670 x 520 x 220
HB Horizontalna verzija za plafonsku montažu (maska sa rešetkom za usis vazduha sa prednje strane)													
	Mod.	FX-HB 130S	FX-HB 230S	FX-HB 330S	FX-HB 430S	FX-HB 530S	FX-HB 630S	FX-HB 730S	FX-HB 830S	FX-HB 930S	FX-HB 1030S	FX-HB 1130S	FX-HB 1230S
	(*) kg	15,7	16,2	19,2	20,0	25,9	26,9	30,0	31,5	34,6	36,1	38,1	41,6
	L x H x S	450 x 450 x 215	450 x 450 x 215	650 x 450 x 215	650 x 450 x 215	850 x 450 x 215	850 x 450 x 215	1.050 x 450 x 215	1.050 x 450 x 215	1.250 x 450 x 215	1.250 x 450 x 215	1.450 x 450 x 215	1.450 x 450 x 215
CA Vertikalna ugradna verzija (osnovna; bez maske)													
	Mod.	FX-CA 130S	FX-CA 230S	FX-CA 330S	FX-CA 430S	FX-CA 530S	FX-CA 630S	FX-CA 730S	FX-CA 830S	FX-CA 930S	FX-CA 1030S	FX-CA 1130S	FX-CA 1230S
	(*) kg	11,4	11,9	14,2	15,0	20,2	21,2	23,6	25,1	27,5	29,0	30,3	33,8
	L x H x S	670 x 520 x 220	670 x 520 x 220	870 x 520 x 220	870 x 520 x 220	1.070 x 520 x 220	1.070 x 520 x 220	1.270 x 520 x 220	1.270 x 520 x 220	1.250 x 450 x 215	1.250 x 450 x 215	1.670 x 520 x 220	1.670 x 520 x 220
CB Vertikalna ugradna verzija (usis vazduha sa prednje strane; bez maske)													
	Mod.	FX-CB 130S	FX-CB 230S	FX-CB 330S	FX-CB 430S	FX-CB 530S	FX-CB 630S	FX-CB 730S	FX-CB 830S	FX-CB 930S	FX-CB 1030S	FX-CB 1130S	FX-CB 1230S
	(*) kg	11,3	11,8	14,1	14,9	20,1	21,1	23,4	24,9	27,3	28,8	30,1	33,6
	L x H x S	450 x 450 x 215	450 x 450 x 215	650 x 450 x 215	650 x 450 x 215	850 x 450 x 215	850 x 450 x 215	1.050 x 450 x 215	1.050 x 450 x 215	1.250 x 450 x 215	1.250 x 450 x 215	1.450 x 450 x 215	1.450 x 450 x 215
CH Horizontalna ugradna verzija (osnovna; bez maske) - Kosno izvlačenje filtera nadole, usis vazduha NIJE za kanalsanje													
	Mod.	FX-CH 130S	FX-CH 230S	FX-CH 330S	FX-CH 430S	FX-CH 530S	FX-CH 630S	FX-CH 730S	FX-CH 830S	FX-CH 930S	FX-CH 1030S	FX-CH 1130S	FX-CH 1230S
	(*) kg	11,8	12,3	14,6	15,4	20,6	21,6	24,0	25,5	27,9	29,4	30,7	34,2
	L x H x S	545 x 450 x 215	545 x 450 x 215	745 x 450 x 215	745 x 450 x 215	945 x 450 x 215	945 x 450 x 215	1.145 x 450 x 215	1.145 x 450 x 215	1.345 x 450 x 215	1.345 x 450 x 215	1.545 x 450 x 215	1.545 x 450 x 215
CK Horizontalna ugradna verzija (usis vazduha sa prednje strane; bez maske)													
	Mod.	FX-CK 130S	FX-CK 230S	FX-CK 330S	FX-CK 430S	FX-CK 530S	FX-CK 630S	FX-CK 730S	FX-CK 830S	FX-CK 930S	FX-CK 1030S	FX-CK 1130S	FX-CK 1230S
	(*) kg	11,7	12,2	14,5	15,3	20,5	21,5	23,8	25,3	27,7	29,2	30,5	34,0
	L x H x S	545 x 450 x 215	545 x 450 x 215	745 x 450 x 215	745 x 450 x 215	945 x 450 x 215	945 x 450 x 215	1.145 x 450 x 215	1.145 x 450 x 215	1.345 x 450 x 215	1.345 x 450 x 215	1.545 x 450 x 215	1.545 x 450 x 215

- (*) kg = Neto težina (samo jedinica, bez pakovanja)
- L x H x S = Dužina x Visina x Dubina (dimenzije u mm)

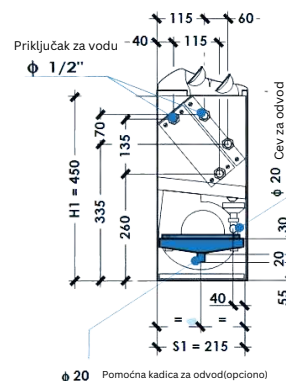
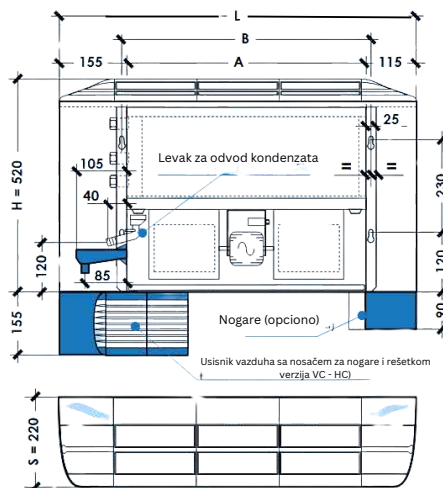

Verzija sa maskom

H = 520 mm
S = 220 mm

Verzija bez maske

H1 = 450 mm
S1 = 215 mm

FX-S(VA)



Nominalni tehnički podaci (jedinice za četverocevni sistem sa AC motorom)

Veličina		FX-S	131S	231S	331S	431S	531S	631S	731S	831S	931S	1031S	1131S	1231S
Kapacitet hlađenja	Total	W	1.000	1.350	1.770	2.080	2.600	2.960	3.820	4.450	4.760	5.790	5.910	6.660
	Senzibilni	W	810	1.030	1.380	1.500	1.880	2.130	2.830	3.150	3.350	3.970	4.360	4.830
Kapacitet grejanja		W	1.260	1.340	2.230	2.340	3.060	3.210	4.360	4.520	5.040	5.190	6.750	6.900
Nominalni protok vazduha		m ³ /h	190	210	280	300	370	400	550	580	610	640	870	900
Protok vode	Hlađenje	l/h	172	232	304	358	447	509	657	765	819	996	1.017	1.146
	Grejanje	l/h	108	115	192	201	263	276	375	389	433	446	581	593
Padovi pritiska vode	Hlađenje	kPa	5,8	7,4	9,0	9,9	10,9	11,7	11,7	13,0	11,5	12,0	11,7	12,9
	Grejanje	kPa	3,3	3,7	5,7	6,3	10,4	11,4	19,7	21,2	15,0	15,9	17,9	18,7
Nivoi buke		Min-Med-Max dB(A)	<10-11-16	<10-11-16	14-16-22	14-16-22	12-13-18	12-13-18	17-19-25	17-19-25	15-18-24	15-18-24	16-21-26	16-21-26
Ref. FAN-DECK			C1.5, A40.6V, [P4-5-6], [N4-5-6]		C2.5, A40.6V, [P4-5-6], [N4-5-6]		C2.5, A80.6V, [P4-5-6], [N4-5-6]		C4, A80.6V, [P4-5-6], [N4-5-6]		C2.5, A80.6V, [P4-5-6], [N4-5-6]		C4, V3-A240, [P4-5-6], [N4-5-6]	
Motori/Ventilatori		No.	1/1		1/1		1/2		1/2		1/2		1/3	
Nominalna ulazna struja		MAX W MAX A	55 W 0,25 A		80 W 0,35 A		80 W 0,35 A		145 W 0,65 A		180 W 0,80 A		290 W 1,30 A	
Napajanje			230Vac-1Ph-50/60Hz											
Grejno/hladni blok	Zapremina vode (l)		0.69	0.70	0.99	1.01	1.30	1.31	1.60	1.62	1.91	1.92	2.21	2.23
	[Ranghi], DN(*) - [Rows], DN(*)		[3R], 1/2" F		[3R], 1/2" F		[3R], 1/2" F		[3R], 1/2" F		[3R], 1/2" F		[3R], 1/2" F	
Grejna spirala	Zapremina vode (l)		0,23		0,33		0,43		0,54		0,64		0,74	
	[Ranghi], DN(*) - [Rows], DN(*)		[1R], 1/2" F		[1R], 1/2" F		[1R], 1/2" F		[1R], 1/2" F		[1R], 1/2" F		[1R], 1/2" F	
Odvodna cev		Ø φ (mm)	20		20		20		20		20		20	
Osnovne dimenzije	L	mm	670		870		1.070		1.270		1.470		1.670	
	H	mm	470		470		470		470		470		470	
	S	mm	220		220		220		220		220		220	
	A	mm	400		600		800		1.000		1.200		1.400	
B	mm	425		625		825		1.025		1.225		1.425		
Donja radna granica	LFI	Max	1,00	1,00	1,00	1,00	1,00	1,00	1,00	1,00	1,00	1,00	1,00	1,00
	ESP = 0 Pa	Med	0,74	0,76	0,75	0,77	0,81	0,80	0,78	0,79	0,75	0,77	0,83	0,83
		Min	0,58	0,62	0,64	0,67	0,73	0,72	0,69	0,71	0,66	0,67	0,68	0,68
SMANJENJE PROTOKA VAZDUHA Koeficijenti koji definišu dijagrame "Protok vazduha / Statički pritisak" (na 3 brzine Maks-Sred-Min)	15 Pa	Max	0,81	0,81	0,84	0,84	0,81	0,81	0,87	0,87	0,91	0,91	0,94	0,94
		Med	0,52	0,54	0,59	0,60	0,58	0,57	0,60	0,61	0,65	0,66	0,79	0,79
		Min	0,29	0,31	0,38	0,39	0,48	0,47	0,49	0,50	0,54	0,55	0,64	0,64
	30 Pa	Max	0,61	0,61	0,67	0,67	0,61	0,61	0,73	0,73	0,80	0,80	0,88	0,88
		Med	0,35	0,37	0,42	0,43	0,37	0,37	0,43	0,44	0,54	0,55	0,74	0,74
		Min	/	/	0,14	0,14	0,26	0,26	0,35	0,35	0,43	0,44	0,59	0,59
45 Pa	Max	0,42	0,42	0,47	0,47	0,42	0,42	0,58	0,58	0,66	0,66	0,80	0,80	
	Med	/	/	0,26	0,26	0,19	0,19	0,30	0,30	0,43	0,43	0,67	0,67	
	Min	/	/	/	/	/	/	0,21	0,22	0,32	0,32	0,53	0,53	
LFS	ESP (Pa)	Max	60 Pa	60 Pa	60 Pa	60 Pa	63 Pa	63 Pa	75 Pa	75 Pa	78 Pa	78 Pa	99 Pa	99 Pa
	Qa (x m ³ /h)		x 0,20	x 0,20	x 0,20	x 0,20	x 0,20	x 0,20	x 0,20	x 0,20	x 0,20	x 0,20	x 0,20	x 0,19
	Med	44 Pa	44 Pa	51 Pa	51 Pa	47 Pa	47 Pa	58 Pa	59 Pa	72 Pa	72 Pa	94 Pa	94 Pa	
Gornja radna granica	ESP (Pa)	Min	25 Pa	26 Pa	30 Pa	30 Pa	39 Pa	39 Pa	50 Pa	51 Pa	63 Pa	63 Pa	89 Pa	89 Pa
	Qa (x m ³ /h)		x 0,13	x 0,13	x 0,14	x 0,14	x 0,16	x 0,16	x 0,16	x 0,16	x 0,18	x 0,18	x 0,19	x 0,18
	Med	44 Pa	44 Pa	51 Pa	51 Pa	47 Pa	47 Pa	58 Pa	59 Pa	72 Pa	72 Pa	94 Pa	94 Pa	

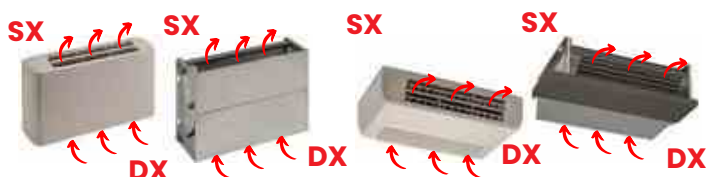

Navedite stranu priključaka za vodu

- SX = Levo (STANDARD)
- DX = Desno

Veličina	FX-S	131S	231S	331S	431S	531S	631S	731S	831S	931S	1031S	1131S	1231S
Ukupni kapacitet hlađenja	W	1.000	1.350	1.770	2.080	2.600	2.960	3.820	4.450	4.760	5.790	5.910	6.660
Ukupni kapacitet grejanja	W	1.260	1.340	2.230	2.340	3.060	3.210	4.360	4.520	5.040	5.190	6.750	6.900
Protok vazduha	m ³ /h	190	210	280	300	370	400	550	580	610	640	870	900
Nivo buke	Min-Med-Max dB(A)	<10-11-16	<10-11-16	14-16-22	14-16-22	12-13-18	12-13-18	17-19-25	17-19-25	15-18-24	15-18-24	16-21-26	16-21-26
VA Vertikalna verzija za montažu na zid (osnovno maska)													
	Mod.	FX-VA 131S	FX-VA 231S	FX-VA 331S	FX-VA 431S	FX-VA 531S	FX-VA 631S	FX-VA 731S	FX-VA 831S	FX-VA 931S	FX-VA 1031S	FX-VA 1131S	FX-VA 1231S
	(*) kg	15,1	15,6	18,1	18,9	24,3	25,3	27,9	29,4	32,0	33,5	35,0	38,5
	L x H x S	670 x 520 x 220		870 x 520 x 220		1.070 x 520 x 220		1.270 x 520 x 220		1.470 x 520 x 220		1.670 x 520 x 220	
VB Vertikalna verzija za montažu na pod (maska sa rešetkom za usis vazduha sa prednje strane)													
	Mod.	FX-VB 131S	FX-VB 231S	FX-VB 331S	FX-VB 431S	FX-VB 531S	FX-VB 631S	FX-VB 731S	FX-VB 831S	FX-VB 931S	FX-VB 1031S	FX-VB 1131S	FX-VB 1231S
	(*) kg	15,4	15,9	18,6	19,4	25,0	26,0	28,8	30,3	33,1	34,6	36,3	39,8
	L x H x S	670 x 520 x 220		870 x 520 x 220		1.070 x 520 x 220		1.270 x 520 x 220		1.470 x 520 x 220		1.670 x 520 x 220	
HA Horizontalna verzija za plafonsku montažu (osnovna maska)													
	Mod.	FX-HA 131S	FX-HA 231S	FX-HA 331S	FX-HA 431S	FX-HA 531S	FX-HA 631S	FX-HA 731S	FX-HA 831S	FX-HA 931S	FX-HA 1031S	FX-HA 1131S	FX-HA 1231S
	(*) kg	16,3	16,8	19,7	20,5	26,3	27,3	30,3	31,8	34,8	36,3	38,2	41,7
	L x H x S	670 x 520 x 220		870 x 520 x 220		1.070 x 520 x 220		1.270 x 520 x 220		1.470 x 520 x 220		1.670 x 520 x 220	
HB Horizontalna verzija za plafonsku montažu (maska sa rešetkom za usis vazduha sa prednje strane)													
	Mod.	FX-HB 131S	FX-HB 231S	FX-HB 331S	FX-HB 431S	FX-HB 531S	FX-HB 631S	FX-HB 731S	FX-HB 831S	FX-HB 931S	FX-HB 1031S	FX-HB 1131S	FX-HB 1231S
	(*) kg	16,6	17,1	20,2	21,0	27,0	28,0	31,2	32,7	35,9	37,4	39,5	43,0
	L x H x S	670 x 520 x 220		870 x 520 x 220		1.070 x 520 x 220		1.270 x 520 x 220		1.470 x 520 x 220		1.670 x 520 x 220	
CA Vertikalna ugradna verzija (osnovna; bez maske)													
	Mod.	FX-CA 131S	FX-CA 231S	FX-CA 331S	FX-CA 431S	FX-CA 531S	FX-CA 631S	FX-CA 731S	FX-CA 831S	FX-CA 931S	FX-CA 1031S	FX-CA 1131S	FX-CA 1231S
	(*) kg	12,3	12,8	15,2	16,0	21,3	22,3	24,8	26,3	28,8	30,3	31,7	35,2
	L x H x S	450 x 450 x 215		650 x 450 x 215		850 x 450 x 215		1.050 x 450 x 215		1.250 x 450 x 215		1.450 x 450 x 215	
CB Vertikalna ugradna verzija (usis vazduha sa prednje strane; bez maske)													
	Mod.	FX-CB 131S	FX-CB 231S	FX-CB 331S	FX-CB 431S	FX-CB 531S	FX-CB 631S	FX-CB 731S	FX-CB 831S	FX-CB 931S	FX-CB 1031S	FX-CB 1131S	FX-CB 1231S
	(*) kg	12,2	12,7	15,1	15,9	21,2	22,2	24,6	26,1	28,6	30,1	31,5	35,0
	L x H x S	450 x 450 x 215		650 x 450 x 215		850 x 450 x 215		1.050 x 450 x 215		1.250 x 450 x 215		1.450 x 450 x 215	
CH Horizontalna ugradna verzija (osnovna; bez maske) - Kosno izvlačenje filtera nadole, usis vazduha NIJE za kanalsanje													
	Mod.	FX-CH 131S	FX-CH 231S	FX-CH 331S	FX-CH 431S	FX-CH 531S	FX-CH 631S	FX-CH 731S	FX-CH 831S	FX-CH 931S	FX-CH 1031S	FX-CH 1131S	FX-CH 1231S
	(*) kg	12,7 13,2		15,6	16,4	21,7	22,7	25,2		29,2	30,7	32,1	35,6
	L x H x S	545 x 450 x 215		745 x 450 x 215		945 x 450 x 215		1.145 x 450 x 215		1.345 x 450 x 215		1.545 x 450 x 215	
CK Horizontalna ugradna verzija (usis vazduha sa prednje strane; bez maske)													
	Mod.	FX-CK 131S	FX-CK 231S	FX-CK 331S	FX-CK 431S	FX-CK 531S	FX-CK 631S	FX-CK 731S	FX-CK 831S	FX-CK 931S	FX-CK 1031S	FX-CK 1131S	FX-CK 1231S
	(*) kg	12,6	13,1	15,5	16,3	21,6	22,6	25,0	26,5	29,0	30,5	31,9	35,4
	L x H x S	545 x 450 x 215		745 x 450 x 215		945 x 450 x 215		1.145 x 450 x 215		1.345 x 450 x 215		1.545 x 450 x 215	

- (*) kg = Neto težina (samo jedinica, bez pakovanja)
- L x H x S = Dužina x Visina x Dubina (dimenzije u mm)



SMGS DOO

Profesionalna rešenja za ventilaciju i klimatizaciju

Gavrila Principa 11
Novi Sad,
Srbija

Tel: +381 21 6616 539
Tel/Fax: +381 21 6616 467

info@smgs.rs

Posetite naš website
www.smgs.rs

